

USER PROGRAMMING GUIDE

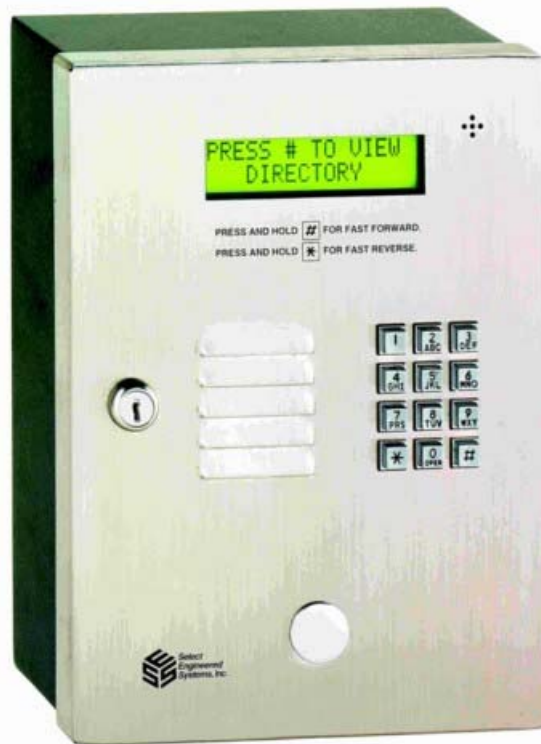

TEC1 Series

COVERS FIRMWARE REVISIONS 1.XX
For models Tec101, TEC1, TEC1C, TEC1CA

Select Engineered Systems, Inc.
7991 West 26th Ave.
Hialeah, FL 33016
Toll Free: 1-800-342-5737
In FL: 305-823-5410
Fax: 305-823-5215
www.selectses.com



This page is intentionally blank

I. FCC REQUIREMENTS

1. The Federal Communications Commission (FCC) has established Rules which permit this device to be directly connected to the telephone network. Standardized jacks are used for these connections. This equipment should not be used on party lines or coin lines.
2. If this unit is malfunctioning, it may also be causing harm to the telephone network. This device should be disconnected until the source of the problem can be determined and until repair has been made. If this is not done, the telephone company may temporarily disconnect service.
3. The telephone company may make changes in its technical operations and procedures. If such changes affect the compatibility or use of this device, the telephone company is required to give adequate notice of the changes. You will be advised of your right to file a complaint with the FCC.
4. If the telephone company requests information on what equipment is connected to their lines, inform them of:
 - a. The telephone number this unit is connected to
 - b. The ringer equivalence number
 - c. The USOC jack required
 - d. The FCC Registration number

Items `b' and `d' are indicated on the label.

The ringer equivalence (REN) is used to determine how many devices can be connected to your telephone line. In most areas, the sum of the RENs of all devices on any one line should not exceed five (5.0). If too many devices are attached, they may not ring properly.

II. SERVICE REQUIREMENTS

1. In the event of equipment malfunction, all repairs should be performed by our Company or an authorized agent. It is the responsibility of users requiring service to report the need for service to our Company or to one of our authorized agents. Service can be obtained at:

Phone: _____

Warning: Changes or modifications not expressly approved by the party responsible for compliance could void the user's authority to operate the equipment.

NOTE: This Equipment has been tested and found to comply with the limits for a Class A digital device. This is pursuant to Part 15 of the FCC Rules. These limits are designed to provide reasonable protection against harmful interference when the equipment is operated in a commercial environment. This equipment generates, uses and can radiate radio frequency energy. If not installed and used in accordance with the instruction manual, may cause harmful interference to radio communications. Operation of this equipment in a residential area is likely to cause harmful interference. If this is the case, the user will be required to correct the interference at his own expense.

Select Engineered Systems, Inc. Life Support Policy

Select Engineered Systems, Inc. products are not intended for use in life critical situations or as critical components in life support devices or systems.

Life Support devices or systems are defined as devices which are intended for surgical implant into the body, or for support or sustaining life, and whose failure to perform, when used in accordance with the instructions provided by the manufacturer, might result in injury to the user.

Select Engineered Systems, Inc. reserves the right to make improvements in the hardware,

TABLE OF CONTENTS

FCC Requirements	2
Using a TEC1	4-5
How to move quickly through directory choices	5
How to call someone	5
If you press the wrong keys	5
How to hang up	5
How to use Personal Identification Number	5
If you press the wrong keys	5
Example Form	6
Programming	7
How to Add a New Name	7
How to Remove a Name or Code	8
How to remove Personal Identification Number	8
How to change phone number	9
How to change title page	10
How to change unlock tone for Entrance 1	10
How to change unlock time for Entrance 1	11
How to change unlock tone for Entrance 2	11
How to change unlock time for Entrance 2	12
How to change talk time	12
How to change displayed code length	13
How to change strike out count	13
How to change program password	14
How to set Clock	15
How to set Time Zone	16
How to set Holidays	17
How to set Access Levels	18
How to Set access Groups	19
How to Set Auto Unlock/Relock Groups	19
Sample Program Form	20
Canadian Notice	21

Covers all TEC1 Series models:
TEC101, TEC1, TEC1C, TEC1CA



USING A TEC1

The TEC1 is an electronic telephone dialer with a directory. The names and “Dialing Code” are presented on a LCD display on the front of the unit. The Telephone Keypad is used to view the Directory, call the resident or enter PIN codes. The TEC1 will also accept **Personal Identification Numbers (PIN’s)** to allow entry.

Use desired	Action	Result
View Names and “Dialing Codes” in Directory	Press # key on keypad. Press # key again. Hold # key Down.	First Name & Code in directory. Next Name & Code in directory Alphabetically. Names will scroll quickly to desired name.
Went Past the Name	Press the * key to backup.	Last Name & Code shown, returns to display.
Call Someone	Enter “Dialing Code” on keypad. Example “123”	You hear number being called Displays: CALLING 123 HIT # TO HANG UP
Entered wrong number	Press # to Stop.	Unit stops call and clears dialing code.
Hang up call	Press # to Stop.	Unit stops call and clears dialing code.
Use a PIN to Enter	Press * and then the PIN.	Display shows: ENTER PIN Then: ACCESS GRANTED
Entered wrong number	Press # to Stop.	Unit stops entry and clears PIN code.
Entered wrong PIN		Display shows: INVALID PIN Then: TRY AGAIN

EXAMPLE FORM—SEE PAGE 15 for reproducible form
Note: Full size form to print available at www.selectses.com

CODE NUMBER 1 - 6 Numbers Example "100"	NAME up to 14 Characters, ALL CAPS Should be Last name first. You do not have to put them in order Example: "SMITH,FRED"	PHONE NUMBER up to 14 Numbers Note: no spaces, no dashes Note: No phone number hides name on directory Example: "3055551212"	PIN NUMBER 1 to 6 Digits Note: Default is 4 Example: "3691"
100	SMITH,FRED	3055551212	3691
101	CANELLAS, B	3055562403	6806
102	ASSOC	3059942532	4126
103	JONES, GORDON	3058457340	2634
104	ADAMSON, JOHN	3059945621	4394
105	BALENT, E	3058457340	2638
106	ALLEN, JOHN	3059945244	4306
107	BARNETT, BETTY	3058484054	2902
109	ANDERSON, A	3059942518	4118
110	LANCE, JACK	3058484054	2906
111	ANDERSON, T	3059942531	4122
112	FRANK, BARNEY	3058446193	2346
113	ARKENBOUT, A	3059945049	4250
114	FREEMAN,ROBERT	3058633597	3222
115	BAILEY, J	3059942777	4190
116	MILLER, R	3058480398	2730
117	SANDERS, BALLO	3059945143	4274
118	TRANTNAM, B	3058637554	3358
119	SCOTT, BARNETT	3059945066	4254
120	PATTEN, JEAN	3058456635	2622

How to Remove a Name or Code

	Step	Action	Result on Display
1	Begin Programming	Press * and 0 at same time.	PASSWORD
2	Enter Password	Press digit password and * Default is '777' and *	MAIN MENU 1
3	Prepare Code (s) To remove	Use form to mark list of codes.	
4	Select Codes / Names	Press 1	CODES/NAMES SELECT 1—8
5	Select Add / New	Press 1	CODE =
6	Enter Code w de- lete (Example: 100)	Press "100" #and *	CODE =
Repeat step 6 for next code or Press * and 0 at same time to end			

How to Remove a Personal Identification Number (PIN)

	Step	Action	Result on Display
1	Begin Programming	Press * and 0 at same time.	PASSWORD
2	Enter Password	Press digit password and * Default is '777' and *	MAIN MENU 1
3	Prepare Code (s) to remove	Use form to mark list of codes.	
4	Select Codes / Names	Press 1	CODES/NAMES SELECT 1—8
5	Select Add / Edit	Press 1	CODE =
6	Enter Code (Example: 100)	Press "100" and *	NAME = SMITH, FRED
7	Skip to PIN	Press * then * then *	PIN= 3691
8	Remove PIN	Press 0	PIN = 0
	Confirm	Press *	
Repeat step 6 for next code or Press * and 0 at same time to end			

How to Change Phone Number

	Step	Action	Result on Display
1	Begin Programming	Press * and 0 at same time.	PASSWORD
2	Enter Password	Press digit password and * Default is '777' and *	MAIN MENU 1
3	Select Code/ Names	Press 1	CODES/NAMES SELECT 1—8
4	Prepare Code # to be changed	Press 1	CODE =
5	Enter Code # to be changed (Example: 123)	Press 123	CODE = 123
6	Skip past name	Press * *	NAME = SMITH, FRED
7	Change Phone #	Press Keys for new Phone # (Example: 333-5678)	3335678
8	Skip past P.I.N.	Press *	PIN = XXXX
9	Confirm	Press *	CODE =
Repeat step 5 for next code or Press * and 0 at same time to end			

How to Change Title Page

	Step	Action	Result on Display
1	Begin Programming	Press * and 0 at same time.	PASSWORD
2	Enter Password	Press digit password and * Default is '777777' and *	MAIN MENU 1-9
3	Select menu	Press 3	SYS. PARAM. SELECT 1-9
4	Select Title Page	Press 9	LINE 1 PRESS # TO
5	Key in characters for Line 1	Press # after each word and last character	(Characters entered)
6	Press *	Select Line 2	VIEW DIRECTORY
7	Key in characters for Line 2	Press # after each word and last character	(Characters entered)
8	Press * *	Stores new Title Page in TEC 101	MAIN MENU 1-9
Press * and 0 at same time to end			

How to Change Unlock Tone for Entrance 1

	Step	Action	Result on Display
1	Begin Programming	Press * and 0 at same time.	PASSWORD
2	Enter Password	Press digit password and * Default is '777777' and *	MAIN MENU 1-9
3	Select menu	Press 2	ENT. CONTROL SELECT 1-2
4	Select Entrance 1	Press 1	ENT. 1 SELECT FUNCTION 1-3
5	Select Tone	Press 2	ENT 1 UNLOCK TONE
6	Press # (Example = 6)	Press 6	ENT 1 UNLOCK TONE = 6
7	Press * *	Changes unlock tone	MAIN MENU 1-9
Press * and 0 at same time to end			

How to Change Unlock Time for Entrance 1

	Step	Action	Result on Display
1	Begin Programming	Press * and 0 at same time.	PASSWORD
2	Enter Password	Press digit password and * Default is '777777' and *	MAIN MENU 1-9
3	Select menu	Press 2	ENT. CONTROL SELECT 1-2
4	Select Entrance 1	Press 1	ENT. 1 SELECT FUNCTION 1-3
5	Select Time	Press 1	ENT 1 UNLOCK TIME
6	Press # (Example = 05)	Press 05	ENT 1 UNLOCK TIME = 05
7	Press * *	Changes unlock time	MAIN MENU 1-9
Press * and 0 at same time to end			

How to Change Unlock Tone for Entrance 2

	Step	Action	Result on Display
1	Begin Programming	Press * and 0 at same time.	PASSWORD
2	Enter Password	Press digit password and * Default is '777777' and *	MAIN MENU 1-9
3	Select menu	Press 2	ENT. CONTROL SELECT 1-2
4	Select Entrance 2	Press 2	ENT. 2 SELECT FUNCTION 1-3
5	Select Tone	Press 2	ENT 2 UNLOCK TONE
6	Press # (Example = 6)	Press 6	ENT 2 UNLOCK TONE = 6
7	Press * *	Changes unlock tone	MAIN MENU 1-9
Press * and 0 at same time to end			

How to Change Unlock Time for Entrance 2

	Step	Action	Result on Display
1	Begin Programming	Press * and 0 at same time.	PASSWORD
2	Enter Password	Press digit password and * Default is '777777' and *	MAIN MENU 1-9
3	Select menu	Press 2	ENT. CONTROL SELECT 1-2
4	Select Entrance 2	Press 2	ENT. 2 SELECT FUNCTION 1-3
5	Select Time	Press 1	ENT 2 UNLOCK TIME
6	Press # (Example = 05)	Press 05	ENT 2 UNLOCK TIME = 05
7	Press * *	Changes unlock time	MAIN MENU 1-9
Press * and 0 at same time to end			

How to Change Talk Time

	Step	Action	Result on Display
1	Begin Programming	Press * and 0 at same time.	PASSWORD
2	Enter Password	Press digit password and * Default is '777777' and *	MAIN MENU 1-9
3	Select menu	Press 3	SYS. PARAM. SELECT 1-9
4	Select Talk Time	Press 1	TALK TIME =
5	Press amount of seconds from 1-99	(Example: 12)	TALK TIME = 12
6	Press * *	Stores new Talk Time in TEC1	MAIN MENU 1-9
Press * and 0 at same time to end			

How to Change Displayed Code Length

	Step	Action	Result on Display
1	Begin Programming	Press * and 0 at same time.	PASSWORD
2	Enter Password	Press digit password and * Default is '777777' and *	MAIN MENU 1-9
3	Select menu	Press 3	SYS. PARAM. SELECT 1-9
4	Select Code Length	Press 3	CODE LENGTH =
5	Press # of displayed digits	(Example: 3)	CODE LENGTH = 3
6	Press * *	Stores new Code Length in TEC1	MAIN MENU 1-9
Press * and 0 at same time to end			

How to Change Strike Out Count

	Step	Action	Result on Display
1	Begin Programming	Press * and 0 at same time.	PASSWORD
2	Enter Password	Press digit password and * Default is '777777' and *	MAIN MENU 1-9
3	Select menu	Press 3	SYS. PARAM. SELECT 1-9
4	Select Code Length	Press 8	STRIKE OUT =
5	Press # of allowed P.I.N. attempts (Example = 3)	Press 3	STRIKE OUT = 3
6	Press * *	Stores Strike Out in TEC1	MAIN MENU 1-9
Press * and 0 at same time to end			

How to Change Password

	Step	Action	Result on Display
1	Begin Programming	Press * and 0 at same time.	PASSWORD
2	Enter Password	Press digit password and * Default is '777777' and *	MAIN MENU 1-9
3	Select menu	Press 4	COMM. SETUP SELECT 1-8
4	Select Change Password	Press 3	PASSWORD =
5	Press # of new Password (Example = 87654)	Press 987654	Password = 987654
6	Press * *	Stores Password in TEC1	MAIN MENU 1-9
Press * and 0 at same time to end			

How to Set Clock

	Step	Action	Result on Display
1	Begin Programming	Press * and 0 at same time.	PASSWORD
2	Enter Password	Press digit password and * Default is '777777' and *	MAIN MENU 1-9
3	Select menu	Press 5	CLOCK SETUP SELECT 1- 3
4	Select Set Clock	Press 1	00:00 00/00/00 Min:
5	Key in Minute	Press XX and * (Some number00 - 59)	00:00 00/00/00 Hour:
6	Key in Hour	Press XX and * (Some number 00 - 23)	00:00 00/00/00 Day:
7	Key in Day of Week (1 =Sun, 7=Sat)	Press X and * (Some number 1 - 7)	00:00 00/00/00 Date:
8	Key in Date	Press XX and * (Some number 1 - 31)	00:00 00/00/00 Month:
9	Key in Month	Press XX and * (Some number 1 - 12)	00:00 00/00/00 Year:
10	Key in Year	Press XX and * (Some number 00 - 99)	00:00 00/00/00
11	Press * *	Stores Time/Date in TEC1	MAIN MENU 1-9

Press * and 0 at same time to end

How to Set Time Zone

	Step	Action	Result on Display
1	Begin Programming	Press * and 0 at same time.	PASSWORD
2	Enter Password	Press digit password and * Default is '777777' and *	MAIN MENU 1-9
3	Select menu	Press 5	CLOCK SETUP SELECT 1- 3
4	Select Time Zone Setup	Press 2	Time Zone <0—7>
5	Key in Time Zone	Press X and * (Some number 0 - 7)	Start Hour: 00
6	Key in Start Hour	Press XX and * (Some number 00 - 23)	Start Min: 00
7	Key in Start Minute	Press XX and * (Some number 00 - 59)	End Hour: 00
8	Key in End Hour	Press XX and * (Some number 00 - 23)	End Min: 00
9	Key in Days of Week 1=Sun, 7=Sat, 8=Holiday	Press X and * (Some number 1 - 8)	DAYS 12345678
11	Press * *	Sets Time Zone in TEC1	MAIN MENU 1-9

Press * and 0 at same time to end

The table below may be used to help keep track of which Time Zones are required for this installation. Writing them down in the table provided will help reduce programming entry errors.

	Start	Time	Stop	Time	Day	of	the	Week				
Time Zone	Hours HH	Min. MM	Hours HH	Min. MM	SU Sun	MO Mon	TU Tue	WE Wed	TR Thur	FR Fri	SA Sat	HOL Hol
0												
1												
2												
3												
4												
5												
6												
7												

How to Set Holidays

	Step	Action	Result on Display
1	Begin Programming	Press * and 0 at same time.	PASSWORD
2	Enter Password	Press digit password and * Default is '777777' and *	MAIN MENU 1-9
3	Select menu	Press 5	CLOCK SETUP SELECT 1- 3
4	Select Holidays	Press 3	Holiday <0—8>
5	Key in Holiday	Press X and * (Some number 0 - 8)	Month:
6	Key in Month	Press XX and * (Some number 1 - 12)	Date:
7	Key in Date	Press XX and * (Some number 01 - 31)	
8	Press * *	Stores Holidays in TEC1	MAIN MENU 1-9
Press * and 0 at same time to end			

The table below may be used to help keep track of which Holidays are required for this installation. Writing them down in the table provided will help reduce programming entry errors. Remember, Holidays may be entered in any order.

Holiday	Month	Day	Holiday
0			
1			
2			
3			
4			
5			
6			
7			
8			

How to Set Access Levels

	Step	Action	Result on Display
1	Begin Programming	Press * and 0 at same time.	PASSWORD
2	Enter Password	Press digit password and * Default is '777777' and *	MAIN MENU 1-9
3	Select Access Control Menu	Press 6	Access Control
4	Select Levels	Press 2	Level: <0—7>
5	Select Time Zone	Press 0—7 and *	Time Zone 0—7
6	Select Entrance	Press 1 or 2 and *	ENT <1—2>
7	Press * *	Stores Access Levels in TEC1	MAIN MENU 1-9

Press * and 0 at same time to end

Use the table below to help keep track of which Access Levels are required for this installation. Writing them down in the table provided will help reduce programming entry errors.

		ENTRANCE															
ACCESS LEVEL	TIME ZONE	1	2	3	4	5	6	7	8	9	10	11	12	13	14	15	16
0																	
1																	
2																	
3																	
4																	
5																	
6																	
7																	

How to Set Access Groups

	Step	Action	Result on Display
1	Begin Programming	Press * and 0 at same time.	PASSWORD
2	Enter Password	Press digit password and * Default is '777777' and *	MAIN MENU 1-9
3	Select Access Control Menu	Press 6	Access Control
4	Select Groups Some # 0-7	Press 1 (Group 0 is Valid 24/7)	Group: <1—7>
5	Select Levels	Press 0—7 and *	Levels - - - - -
6	Press * *	Stores Access Groups in TEC1	MAIN MENU 1-9
Press * and 0 at same time to end			

How to Set Auto Unlock Groups

	Step	Action	Result on Display
1	Begin Programming	Press * and 0 at same time.	PASSWORD
2	Enter Password	Press digit password and * Default is '777777' and *	MAIN MENU 1-9
3	Select Entrance Control Menu	Press 2 and *	Entrance 1-2
4	Select Entrance to Auto Unlock	Press 1 or 2 and *	Auto Group
5	Select Auto Group	Press 3 and *	Group
6			
7	Press * *	Stores Auto Groups in TEC1	MAIN MENU 1-9
Press * and 0 at same time to end			

NOTICE: The Canadian Department of Communications label identifies certified equipment. This certification means that the equipment meets certain telecommunications network protective, operational and safety requirements. The Department does not guarantee the equipment will operate to the user's satisfaction.

Before installing this equipment, users should ensure that it is permissible to be connected to the facilities of the local telecommunications company. The equipment must also be installed using an acceptable method of connection. In some cases, the company's inside wiring associated with a single line individual service may be extended by means of a certified connector assembly (telephone extension cord). The customer should be aware that compliance with the above conditions may not prevent degradation of service in some situations.

Repairs to certified equipment should be made by an authorized Canadian maintenance facility designated by the supplier. Any repairs or alterations made by the user to this equipment, or equipment malfunctions, may give the telecommunications company cause to request the user to disconnect the equipment.

Users should ensure for their own protection that the electrical ground connections of the power utility, telephone lines and internal metallic water pipe system, if present, are connected together. This precaution may be particularly important in rural areas.

Caution: Users should not attempt to make such connections themselves, but should contact the appropriate electric inspection authority, or electrician, as appropriate.

The Load Number (LN) is assigned to each terminal device. This denotes the percentage of the total load to be connected to a telephone loop which is used by the device, to prevent overloading. The termination on a loop may consist of any combination of devices. This is subject only to the requirement that the total Load Numbers of all the devices does not exceed 100.

This digital apparatus does not exceed the Class A limits for radio noise emissions from digital apparatus. This is set out in the Radio Interference Regulations of the Canadian Department of Communications.

Le present appareil numerique n'emet pas de bruits radioelectriques depassant les limites applicables aux appareils numeriques de la Class A prescrites dans le Reglement sur le brouillage radioelectrique edicte par le ministere des Communications du Canada.

End User Programming Section 8/06

End Installer Guide 8/06

Specifications

Outside dimensions:	8 ½" W x 11¾" H x 3 ½" D
Shipping weight:	Approx. 11 lbs.
Power:	18VAC 20VA transformer (supplied).
Construction:	Stainless steel front door, with aluminum back box.
Operating environment:	Temperature: - 0°F to 158°F
Relative humidity:	5% to 95% Non-condensing
Memory type:	Non-volatile
Relay output:	Form A or B dry contact 24 V @ 3 AMPS.
Tone detection:	Crystal controlled, will detect short burst 50 millisecond tone.

How to Change RS232 Speed (300—19200 Baud)

	Step	Action	Result on Display
1	Begin Programming	Press * and 0 at same time.	PASSWORD
2	Enter Password	Press digit password and * Default is '777777' and *	MAIN MENU 1-9
3	Select menu	Press 4	COMM. SETUP SELECT 1-8
4	Select RS232 Baud Rate	Press 2	RS232 BAUD =
5	Press # 1 - 6 (Example = 5)	Press 5	RS232 BAUD = 5
6	Press * *	RS232 Baud Speed stored in TEC1	MAIN MENU 1-9
Press * and 0 at same time to end			

BAUD TABLE:

0 = 300
 1 = 600
 2 = 1200
 3 = 2400
 4 = 4800
 5 = 9600
 6 = 19200

How to Set Parameters (Set TEC1 to Factory Default settings)

	Step	Action	Result on Display
1	Begin Programming	Press * and 0 at same time.	PASSWORD
2	Enter Password	Press digit password and * Default is '777777' and *	MAIN MENU 1-9
3	Select menu	Press 8	CLEAR DATA SELECT 1-6
4	Select Set Parameters	Press 1	DESTROYS RECORD CONTINUE? 1/0
5	Press 1 or 0 (Example = 1)	Press 1	FUNCTION DONE
6	Press * *	Sets Parameters in TEC 101	MAIN MENU 1-9
Press * and 0 at same time to end			

How to Change Terminal Type (VT-100 or Simple Terminal Display)

	Step	Action	Result on Display
1	Begin Programming	Press * and 0 at same time.	PASSWORD
2	Enter Password	Press digit password and * Default is '777777' and *	MAIN MENU 1-9
3	Select menu	Press 4	COMM.SETUP SELECT 1-8
4	Select Terminal Type	Press 1	TERM TYPE =
5	Press 1 or 0 (Example = 1)	Press 1	TERM TYPE = 1
6	Press * *	Stores Terminal Type in TEC1	MAIN MENU 1-9
Press * and 0 at same time to end			

How to enable Keypad

(Whether keypad #'s 0-9 are active after dialing)

	Step	Action	Result on Display
1	Begin Programming	Press * and 0 at same time.	PASSWORD
2	Enter Password	Press digit password and * Default is '777777' and *	MAIN MENU 1-9
3	Select menu	Press 3	COMM. SETUP SELECT 1-8
4	Select Keypad Enable	Press 7	KEYPAD ON =
5	Press 1 or 0 (Example = 1)	Press 1	KEYPAD ON = 1
6	Press * *	Stores Keypad Enable in TEC1	MAIN MENU 1-9
Press * and 0 at same time to end			

How to Clean Codes

(Automatically deletes corrupted codes)

	Step	Action	Result on Display
1	Begin Programming	Press * and 0 at same time.	PASSWORD
2	Enter Password	Press digit password and * Default is '777777' and *	MAIN MENU 1-9
3	Select menu	Press 8	CLEAR DATA SELECT 1-6
4	Select Clean Codes	Press 6	DESTROYS RECORD CONTINUE? 1/0
5	Press 1 or 0 (Example = 1)	Press 1	CLEANING CODES
6	Press * *	Codes Cleaned in TEC1	MAIN MENU 1-9
Press * and 0 at same time to end			

How to Change Ring Count

(Number of incoming rings before TEC1 answers)

	Step	Action	Result on Display
1	Begin Programming	Press * and 0 at same time.	PASSWORD
2	Enter Password	Press digit password and * Default is '777777' and *	MAIN MENU 1-9
3	Select menu	Press 3	SYS. PARAMETERS SELECT 1-9
4	Select Ring Count	Press 7	RING COUNT =
5	Press # rings 1-9. (Example = 3)	Press 3	RING COUNT = 3
6	Press * *	Stores Ring Count in TEC1	MAIN MENU 1-9
Press * and 0 at same time to end			

How to disable Directory Display

(Whether Directory displays or not)

	Step	Action	Result on Display
1	Begin Programming	Press * and 0 at same time.	PASSWORD
2	Enter Password	Press digit password and * Default is '777777' and *	MAIN MENU 1-9
3	Select menu	Press 4	COMM. SETUP SELECT 1-9
4	Select Directory display on/off	Press 6	DIRECTORY ON =
5	Press 1 or 0 (Example = 1)	Press 1	DIRECTORY ON = 1
6	Press * *	Stores Directory display in TEC1	MAIN MENU 1-9
Press * and 0 at same time to end			

How to Enable Background Beep (Beeps every 10 seconds in background)

	Step	Action	Result on Display
1	Begin Programming	Press * and 0 at same time.	PASSWORD
2	Enter Password	Press digit password and * Default is '777777' and *	MAIN MENU 1-9
3	Select menu	Press 3	SYS. PARAMETERS SELECT 1-9
4	Select Background Beep	Press 5	BACK BEEP =
5	Press 1 or 0 (Example = 1)	Press 1	BACK BEEP = 1
6	Press * *	Stores Back Beep in TEC1	MAIN MENU 1-9
Press * and 0 at same time to end			

How to Enable Pulse Dial (Dials out Rotary Pulses)

	Step	Action	Result on Display
1	Begin Programming	Press * and 0 at same time.	PASSWORD
2	Enter Password	Press digit password and * Default is '777777' and *	MAIN MENU 1-9
3	Select menu	Press 3	SYS. PARAMETERS SELECT 1-9
4	Select Tone Dial	Press 6	TONE DIAL =
5	Press 1 or 0 (Example = 0)	Press 0	TONE DIAL = 0
6	Press * *	Stores Pulse Dial in TEC1	MAIN MENU 1-9
Press * and 0 at same time to end			

How to Change P.I.N. Length

	Step	Action	Result on Display
1	Begin Programming	Press * and 0 at same time.	PASSWORD
2	Enter Password	Press digit password and * Default is '777777' and *	MAIN MENU 1-9
3	Select menu	Press 3	SYS. PARAMETERS SELECT 1-9
4	Select Change P.I.N. Length	Press 4	PIN LENGTH =
5	Press # of new P.I.N. Length (Example = 3)	Press 3	PIN LENGTH = 3
6	Press * *	Stores P.I.N. Length in TEC1	MAIN MENU 1-9
Press * and 0 at same time to end			

How to Change P.I.N. on Entrance (Whether P.I.N. operates Entrance 1 or 2)

	Step	Action	Result on Display
1	Begin Programming	Press * and 0 at same time.	PASSWORD
2	Enter Password	Press digit password and * Default is '777777' and *	MAIN MENU 1-9
3	Select menu	Press 4	COMM. SETUP SELECT 1-9
4	Select PIN on Entrance	Press 4	PIN ON ENT =
5	Press 1 or 2 (Example = 2)	Press 2	PIN ON ENT = 2
6	Press * *	Stores P.I.N. Entrance in TEC1	MAIN MENU 1-9
Press * and 0 at same time to end			

**TEC1 Accessories:
OPTEC1W2-1**

MAIN BOARD

**TURN OFF POWER SWITCH
before connecting ANY TEC1
accessory.**

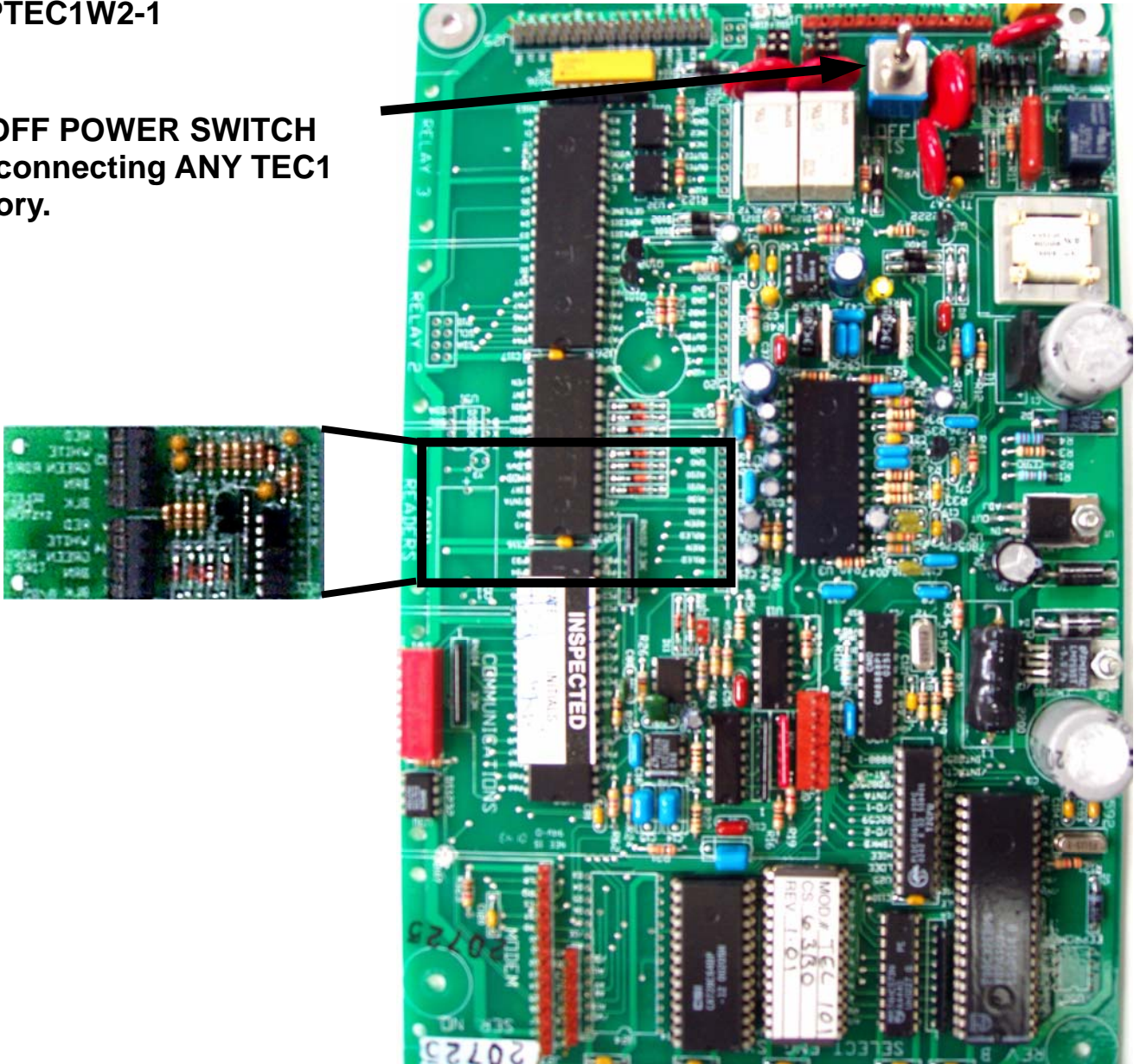

Reader 2 Power (Red)
Reader 2 D1 (White)
Reader 2 D0 (Green)
Reader 2 LED (Brown)
Reader 2 Common (Black)

Reader 1 Power (Red)
Reader 1 D1 (White)
Reader 1 D0 (Green)
Reader 1 LED (Brown)
Reader 1 Common (Black)

Wire = Belden #9941
(Or close equivalent.)
Maximum distance = 500 feet.

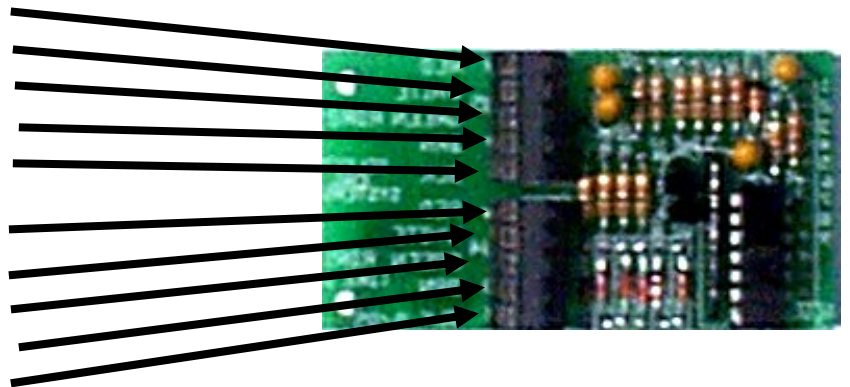

**Card Reader Module
Wiring connections**

TEC1 Accessories:

- OPTKMUI**
- OPTKMODEM56K**
- OPTKNIC**
- OPTKSERIAL**

Phone Line Sharing Interface.
Shares 1 phone line with up to 4 TEC1's

OPTKMUI

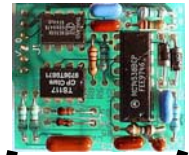

TURN OFF POWER SWITCH
before connecting ANY TEC1
accessory.

MAIN BOARD

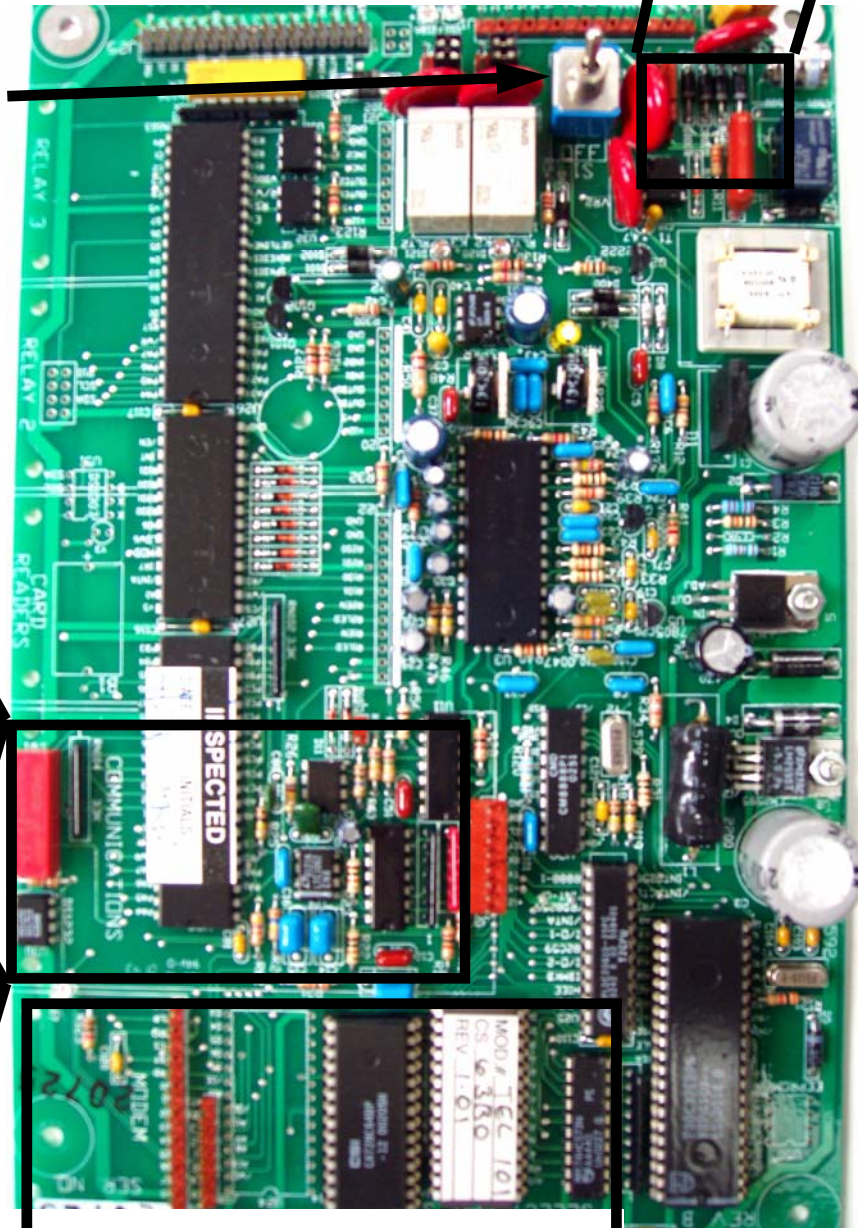

Network interface card for RJ-45 Ethernet communications.
Use Selcom TecBasic and Lantronix Com Re-Director.

OPTKNIC



OR

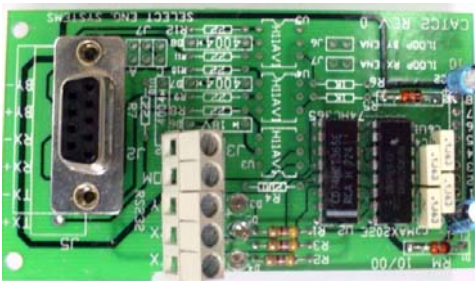

OPTKSERIAL

Serial port. Connect 9 pin cable. Set laptop or computer to 9600 baud n,8,1.
Maximum serial cable length = 100 feet.



OPTKMODEM56K

56-K baud modem.
Use with Selcom TecBasic software or other terminal communications program.

Display/Ribbon Connector

Power Harness Connector

MAIN BOARD

POWER Switch
Turn off before removing or installing accessories

MORE
MIKE Sensitivity

LESS
NOTE: If adjusted incorrectly, TEC1 Will NOT work properly.

MORE
SPEAKER Volume

LESS
1 Program enable
2 Speaker enable
3 Always OFF
4 Reserved
5 Reserved
6 Reserved
7 Always ON
8 Reset

S1 Switch Selection Descriptions

POWER Indicator
If flashing, call for service.

Darker ← → Lighter

Display Board

Display contrast adjustment on display board.

Adjust Here

Relay Jumper Selection on Main Board

Normally Closed (N/C)

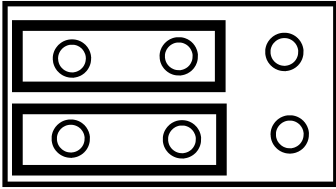

Set jumpers like this for normally closed.

Normally Closed (N/C)

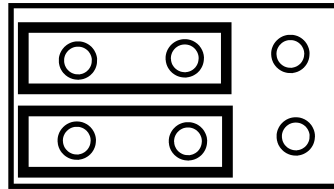

Normally Open (N/O)

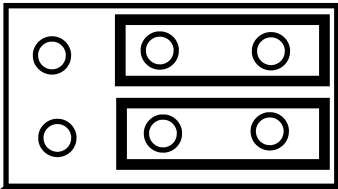

Set jumpers like this for normally open.

Normally Open (N/O)

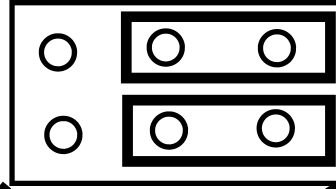

Door 2
Relay Jumper
Settings

Door 1
Relay Jumper
Settings

MAIN BOARD



NOTE:
BOTH jumpers must be moved to select normally open, or normally closed contacts.

Factory Settings are set to select normally open contacts.

Relays may be set in any combination of: normally open, or normally closed contacts.

6) Connect the wires for the power connections to connectors 3 & 4, as shown below. Connect the other ends of the wires to the screws on the supplied transformer (16.5 vac 20 va). Plug the transformer into a 110vac outlet.

7) If you are using the N.O. contacts on the entrance 1 relay, connect the wires from the controlled device to connectors 9 & 10, as shown below. To use the N.C. contacts, change the relay jumpers and connect the wires from the controlled device to connectors 9 & 10. Wire entrance 2 relay to connectors 11 & 12 in the same manner.

NOTE: THE RELAY CONTACTS ARE RATED FOR 24 VOLTS AC OR DC AT 3 AMPS MAXIMUM.

8) Connect the modular plug for the telephone line to the RJ-11 jack provided by the phone company. No other telephones or equipment should be on this line. If attaching multiple Tec1's to a single phone line, the optional OPTKMUI (Multiple Unit Interface) may be purchased.

9) All wire openings, or any penetration of the Tec1 enclosure should be sealed with a good grade of RTV silicon sealant.

10) This completes the installation

CONNECTIONS

Use 16 Ga. Or larger.
TEC1 MUST be grounded to Earth
Ground or cold water pipe.

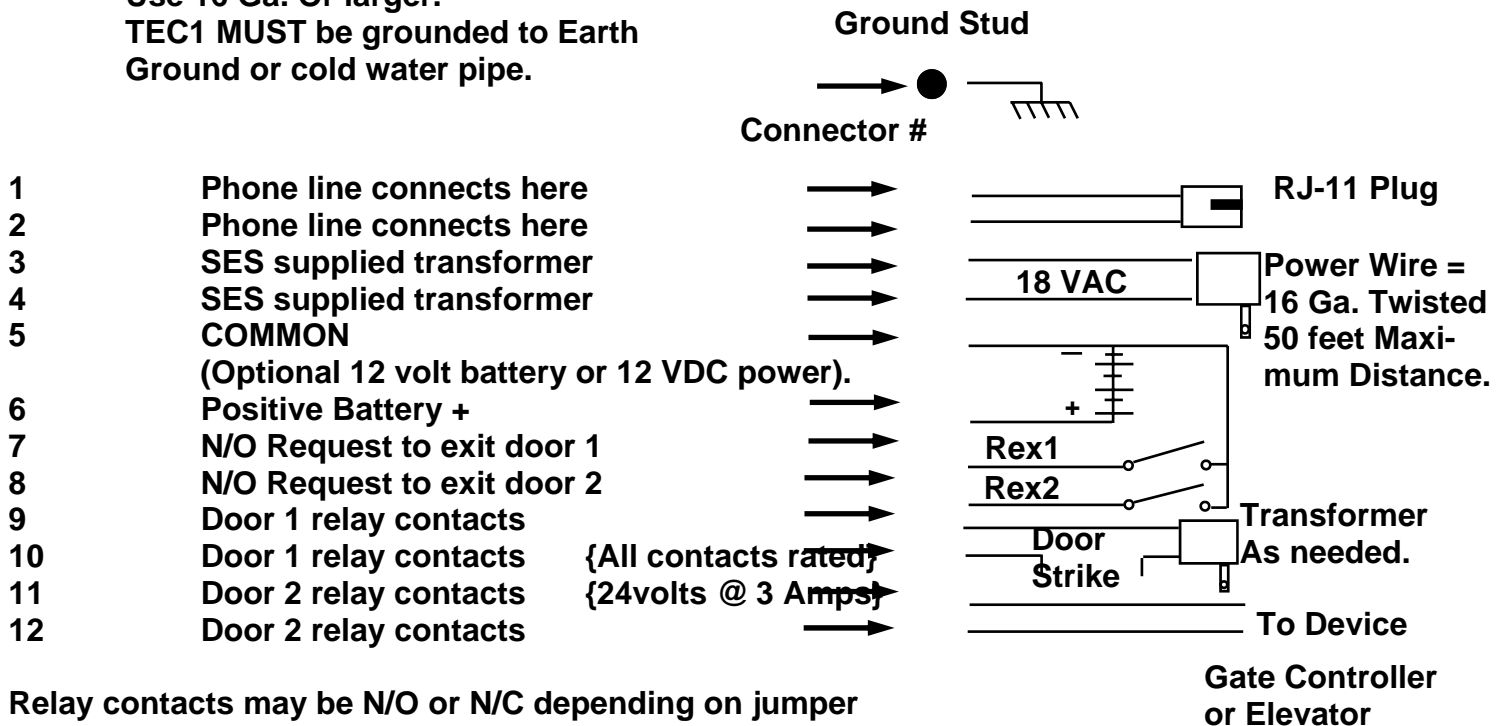

Relay contacts may be N/O or N/C depending on jumper selection.

INSTALLATION INSTRUCTIONS

- A. Never install telephone wiring during a lightning storm.
- B. Never install telephone jacks in wet locations unless the jack is specifically designed for wet locations.
- C. Never touch un-insulated telephone wires or terminals unless the telephone line has been disconnected at the network interface.
- D. Use caution when installing or modifying telephone lines.

Installation of Tec1 requires coordination with your telephone company. SES recommends that a Touch-Tone™ line be installed to allow much faster dialing. If a Touch-Tone™ line is not available, the Tec1 can be reprogrammed to dial out pulse (rotary) signals.

The phone company may require the following information:

The ringer equivalence number.

The FCC registration number.

These numbers are on the label on the inside door of the Tec1.

The desired location of the telephone jack must be given to the phone company at the time the phone line is ordered.

INSTALLATION PROCEDURE

- 1) The Tec1 should be mounted approximately 52 inches above finished floor to the center of the Tec1. For drive up applications, Tec1 should be mounted approximately 42" - 48" above finished flooring to the center of Tec1. Hand set units (Optional, Call Factory) should be mounted 40" - 46" above finished floor to help comply with the Americans with Disabilities Act (ADA).
- 2) To surface mount the Tec1, mount the back-box using the holes provided.
- 3) To flush mount the Tec1, cut a hole the size of the back box (8 ½" wide X 11 ¾" high) in the wall. Mount the Tec1 in the hole.

LEAVE ½" SPACE FROM THE REAR OF THE DOOR TO THE WALL, SO THE DOOR WILL OPEN.

4) We recommend an optional weather hood (Call Factory for availability) when mounting Tec1 in a stand-alone application, to protect it from direct exposure to rain and snow.

5) The Tec1 **MUST BE AT EARTH GROUND POTENTIAL**. Connect a #16 stranded or larger wire from the ground lug mounted on the back-box of the Tec1 to a cold water pipe or other suitable ground. This wire should be less than 50 feet in length.

TABLE OF CONTENTS

Installation Instructions	4
Hook up Instructions	5
Relay Jumper Selections	6
Mike Adjustment	7
Speaker Adjustment	7
Display Adjustment	7
Switch Definitions	7
Accessories	
OPTKMUI	8
OPTKNIC	8
OPTKSERIAL	8
OPTKMODEM56K	8
OPTTEC1W2-1	9
How to change P.I.N. Length	10
How to change P.I.N. on Entrance	10
How to enable Background Beep	11
How to enable Pulse Dial	11
How to change Ring Count	12
How to change Directory Display	12
How to change Keypad Enable	13
How to Clean Codes	13
How to Set Factory Parameters	14
How to change Terminal Type	14
How to change RS232 Baud	15
Specifications	16

This page is intentionally blank

INSTALLER GUIDE



TEC1 Series

COVERS FIRMWARE REVISIONS 1.XX
For models Tec101, TEC1, TEC1C, TEC1CA



Select Engineered Systems, Inc.
7991 West 26th Ave.
Hialeah, FL 33016
Toll Free: 1-800-342-5737
In FL: 305-823-5410
Fax: 305-823-5215
www.selectses.com